

CALIBRATION ADAPTER - 3/8", 9+10 MM HEX ZJ2-10

Related products

TES225

Line Checker TES 2,5 ~ 25 Nm

TES275

Line Checker TES 7,5 ~ 75 Nm

TES240

Line Checker TES 4 ~ 40 Nm

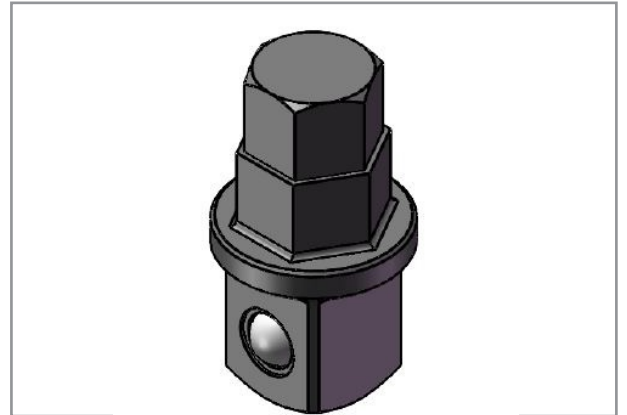

Specifications

Brand	NovaTork
Square Drive	3/8"
Hexagon	9+10
EAN	8717981440115