



RRI-BIM25T

Manual

EN

www.rami-yokota.com



Before taking into use

Read and understand the contents of this manual before installing, operating, repairing, maintaining, changing accessories of this tool.

Only qualified and trained operators should install, adjust or use the tool.

Charging the battery

Slide the battery in the charger, this should go smoothly otherwise the alignment isn't correct or the battery / charger grooves are damaged. In that case check the battery and charger and replace the damaged item, do not repair.



Cool down the charger when charging more than two battery packs consecutively.

Do not insert your fingers/ nails into contact hole, when holding charger or any other occasions.

Place charger in a relatively cool and well-ventilated area.

Plug charger into the AC outlet. CAUTION: Ensure that the power source to be utilized conforms to the power requirement specified on the product nameplate.

If the power lamp (red) does not light immediately or goes out soon after the charger is plugged in, consult an authorized dealer.

During charging, the charging lamp (green) will start flashing. When charging is completed, an internal electronic switch will automatically be triggered to prevent overcharging.

Charging will not start if the battery pack is warm. For example, immediately after heavy-duty operation. The yellow standby lamp will be flashing until the battery cools down.

Once the battery is fully charged, the green lamp will be lit to indicate the gone into a trickle charge mode.

Mounting the battery:

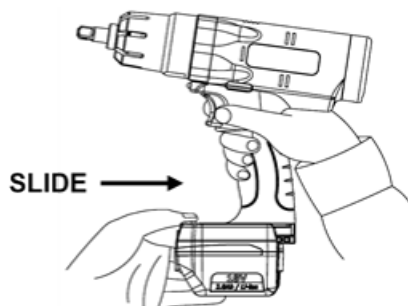

Removing the battery:

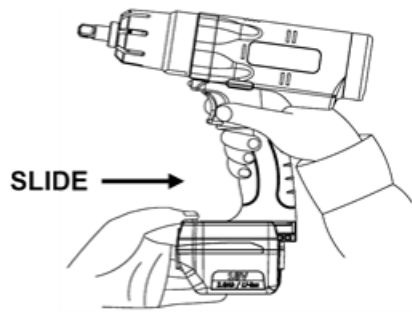

Battery charger Lamp Indication:

		Red Lamp Charger is plugged into the AC outlet. Ready to charge.
		Yellow Flashing (1) When the temperature of the battery is too low ($<0^{\circ}\text{C}$ ($<32^{\circ}\text{F}$)), it is in a trickle charge mode until the temperature of the battery goes up to over 0°C ($<32^{\circ}\text{F}$). The lamp will change from the Yellow Flashing to Green Flashing automatically and start to charge. (If after 70 minutes, the lamp changes from yellow flashing to yellow lit, consult an authorized dealer.) (2) When the temperature of the battery is too high ($>40^{\circ}\text{C}$ (104°F)), it is in a trickle charge mode until the temperature of the battery drops to under 40°C (104°F). The lamp will change from the Yellow Flashing to Green Flashing automatically and start to charge. (If after 70 minutes, the lamp changes from yellow flashing to yellow lit, consult an authorized dealer.) (3) When the voltage of the battery is too low (below 14.4 voltage), it is in a trickle charge mode until the voltage of the battery reaches to the standard value. The lamp will change from the Yellow Flashing to Green Flashing automatically and start to charge. (If after 20 minutes, the lamp changes from yellow flashing to yellow lit, consult an authorized dealer.)
		Yellow Lamp The battery and the charger are not connected. If the yellow lit still on after trying re-attach the battery, consult an authorized dealer.
		Green Flashing Now start charging
		Green Flashing Battery is approximately 50% charged.
		Green Flashing Battery is approximately 80% charged.
		Green Lamp Charging is complete. (Fully charged.)

Overheating of the motor.

During intensive use the motor may get overheated, maximum number of cycles per minute is depending on the torque and number of impulses. At maximum torque and shut-off set at 9 the maximum number of cycles is 6 per minute.

Do not ignore safety precautions!

Safety

Do not modify this tool in any way, this can cause danger for the operator.

Make sure that this manual is accessible at all times for any relevant person, in case of loss of this manual ask your dealer for a new copy or refer to our website.

Risk of explosion or fire: Make sure that generated sparks and/or increased temperature of the work piece can not cause any explosion or ignite a fire.

Make sure that during operation of the tool no projectiles can be generated, this can be dangerous and may cause injuries.

Make sure that the work piece is securely fixed.

Make sure that the inserted tool or accessory is mounted correctly, if not it may cause high speed projectiles.

Make sure that no dangerous circumstances can occur for other persons in the work area.

Always wear safety glasses during operation of the tool. The grade of protection must be in relation to the risk of the operation.

Rotating mounted accessories can be easily entangled by rubber coated or metal reinforced gloves. Wear suitable gloves.

Keep fingers out of reach of the inserted tool or accessory.

Never hold the drive shaft, socket, bit, inserted/mounted tool/accessory with your hands while rotating.

For impact and impulse wrenches: Only use impact sockets, see our Action catalogue.

The use of safety-/working gloves is recommended.

Use ear protection as instructed by your employer or as required by occupational health and safety requirements.

Reasonable countermeasures have to be taken to keep the noise level as low as possible.

Always check that the mounted tool or accessory is not damaged. Breakage and flying fragments can cause injuries.

Keep rotating parts out of reach of any body part.

In case of long hair, wear a hairnet otherwise it can be trapped causing injuries.

Never wear loose clothing, wear suitable clothing otherwise it can be trapped causing injuries.

Only use accessories for this tool that are designated for this tool by its manufacturer.

Convince yourself that no persons are in the working zone or danger zone.

The advised minimum age for operating this tool is 18 years.

This tool is not intended for use in potential explosive hazardous areas and is not insulated from coming into contact with electric power.

Wear the appropriate clothing to feel comfortable at the workplace.

On overhead work, use safety helmet.

Due to the process, the work piece, inserted/mounted tool/accessory may get hot causing burning injuries: Be aware of this.

Never let the tool run free in the air: the accessory may come loose and become a projectile causing danger or injury

Only use accessories that are in good condition, worn accessories can be dangerous and cause injuries.

Only trained and qualified operators should use the tool.

Never use a damaged tool.

Tools shall be inspected periodically to verify that the ratings and markings required by the applicable part of the ISO 11148 series are legibly marked on the tool. If not the user/employer shall obtain replacement labels from the dealer or manufacturer.

Use only tight fitting gloves, loose gloves can be trapped or entangled causing injuries.

Use the specified gloves for the application that protects against: heat, cold, entanglement, cutting, impacting

Do not wear any shawls jewelry etc that can be trapped or entangled causing injuries.

In case of power loss, release the trigger immediate.

Make the possible countermeasures to minimize noise emission: if possible, use silence materials on the workpiece or walls around the work station.

A risk assessment related to the noise emission at the work station on the work piece has to be made to determine the correct ear protection according to health and safety regulation.

A risk assessment related to the vibration exposure to determine the maximum working hours per day for the operator. Vibration can cause damage to blood vessels and nerves (white finger disease). Hold the tool with light but safe grip, higher grip force can increase vibration effects.

Electrical Safety

This product is for the indoor exclusive use. Do not use it in rain, in a damp place and a wet place. Moreover, never use it in a place with the fear of the ignition and the explosion, because those are hazardous situations.

Do not move by holding the power cord. Do not pull the cord to remove the plug from the socket-outlet.

Avoid damage of cord due to stepping, entangling, or unreasonable force, a damaged cable must be replaced immediately.

Avoid pinching of power cord in the object to be tightened or surrounding facility in the tool operation and avoid the contact with rotating parts. The power cord may be damaged and it may result in accidents.

Use the battery charger at rated supply voltage (AC 100-240 V).

Do not use DC power supply, engine generator, or power transformer.

Keep away from sources generating large electromagnetic noise, such as welder, DC brush motor.

Be sure to use the provided power supply cord. Use of other power supply cord may cause malfunction, heat generation, or fire.

Be sure to fully insert the power plug. Failure to do so may result in electric shock or fire due to heat generation.

If you do not use the product, unplug from the receptacle.

Wipe out dust or stain accumulated on the power plug or receptacle with a dry cloth. Failure to do so may result in electric shock or fire.

Do not insert or remove the power plug from the receptacle with wet hand. Doing so may result in electric shock.

Never disassemble or modify the charger.

Accessories

Only use accessories and consumables that are designed for the use with this tool.

Select the best available inserted/mounted accessories/consumables for the lowest possible noise level and vibration. Replace them in case of an increased noise level and/or vibration.

Do not use worn or bad fitting impact sockets or extensions, as this is likely to increase noise and vibration.

Make sure that the inserted/mounted tool/accessory is properly held by the retainer and make sure that the retainer is in good condition. Never use the tool without a retainer as this may cause high speed projectiles.

Only use impact rated sockets when using impact or impulse wrenches.

Using the tool:

Before start using the tool, make sure that you are familiar with the workplace and surrounding area.

Always obey the safety regulations for the work area you are working in.

During operating the tool, the operator may be exposed to hazards as crushing, impacts, heat, vibration, cuts, abrasions, etc: Wear suitable gloves.

Any person handling the tool must be able to handle the size, weight and power of the tool.

Always be prepared for normal/abnormal movements/forces generated by the tool.

Keep your body in balance, place your feet safe and secure.

Take care of the reaction forces, if the tool (suddenly) stalls.

When using a power tool, you may experience discomfort in your hands, arms, shoulders, neck and other parts of your body.

If you experience symptoms such as persistent or recurring discomfort, pain, throbbing, aching, tingling, numbness, burning sensation, or stiffness: Do not ignore these warning signs. Stop using the tool, tell your employer and consult a qualified health professional.

Check if the direction of rotation is in the required direction.

Adjust the torque according the requirements for the application, see below paragraph: Adjustments.

Place the tool with the accessory on the bolt/nut screw.

Pull the trigger to start the tool and release the trigger to stop the tool.

Do not overtighten the bolt/nut/screw, a broken part can become a projectile causing danger or injury.

When loosening the bolt/nut/screw may become a projectile causing danger or injury.

Operator should change posture regularly to avoid discomfort and fatigue.

Use hear protection according to employer, health and safety regulations.

Torque adjustment

Remove the battery before adjusting.

Rotate the main shaft until the hole (2 mm) of the valve screw is in front a groove, for the RRI-BIM15T please remove the small screw. Clockwise = increase torque output, counterclockwise = decrease torque output.

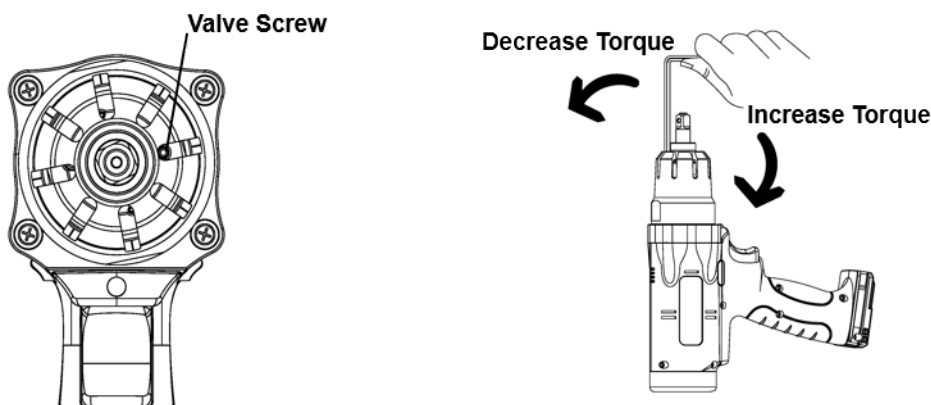

How to test the torque

Test method 1: Static measurement, either on a test joint or actual application. Measure the move on torque with a torque wrench.

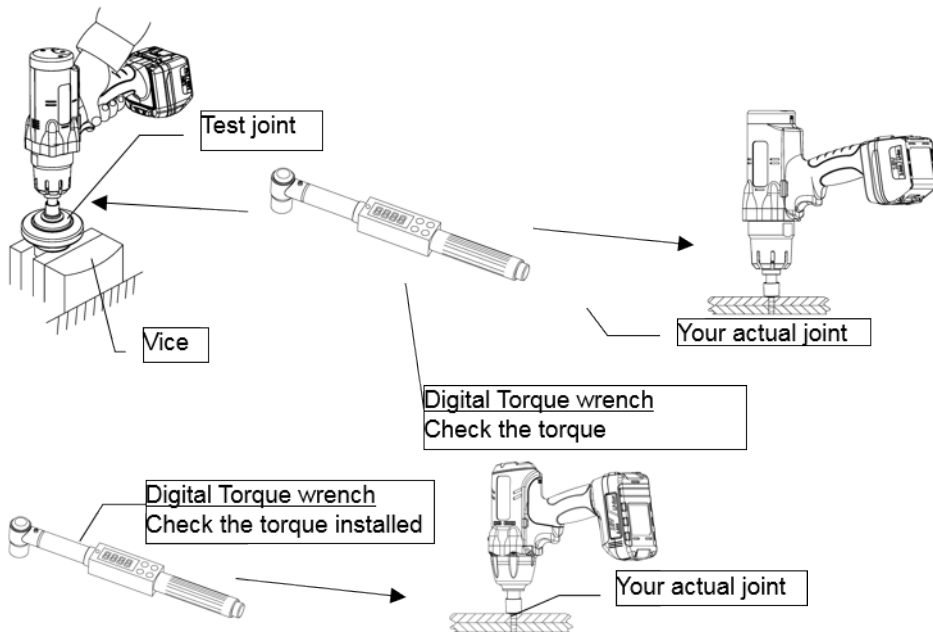

Test method 2: dynamic measurement with a rotary torque transducer on a test joint.

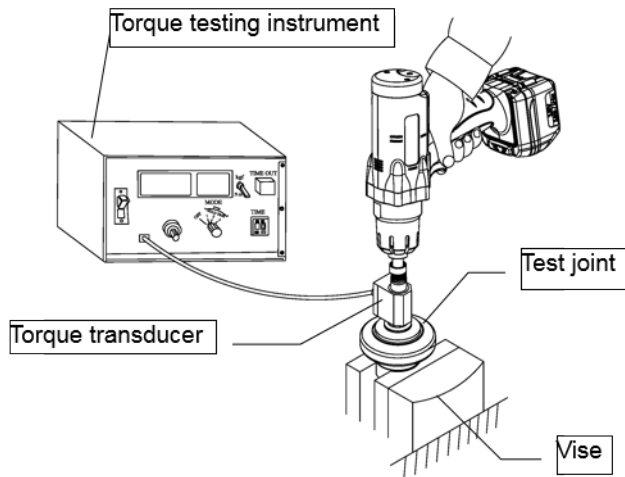

Test method 3: dynamic measurement with a rotary torque transducer on the actual application.

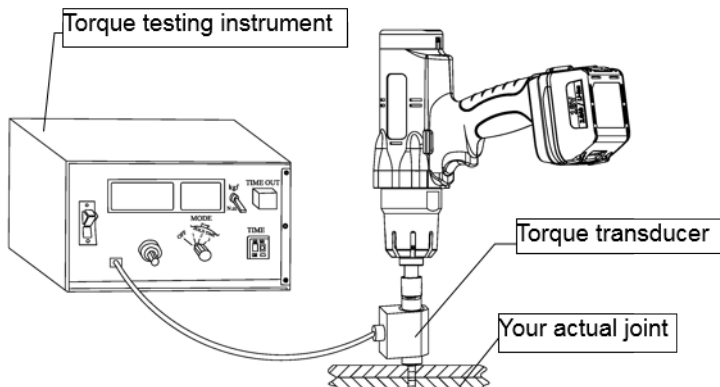

Adjustment of the shut-off.

Step 1 – 9. Step 1 = very quick shut-off, step 9 = longer impulsing before shut-off, please adjust according the hardness of the actual joint (a too quick shut-off will have a negative influence on the accuracy)

Hard joint: 2 – 3 – 4

Middle hard joint: 4 – 5 – 6

Soft joint: 6 – 7 – 8 – 9

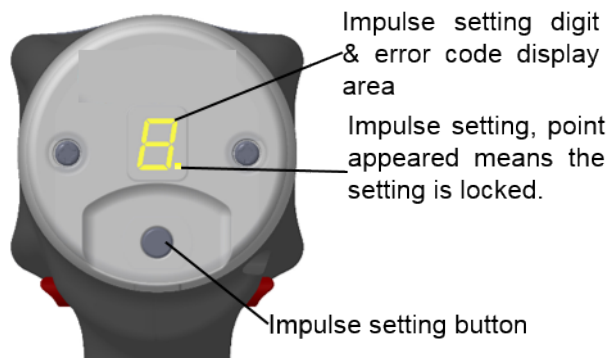

Push the button for 2 seconds until the number starts blinking.

Set the requested number.

Wait 5 seconds until the number stops blinking or pull the trigger.

Locking the shut-off setting:

Remove the battery.

Push the trigger and L/R switch simultaneously and place the battery, hold the trigger and L/R switch until the tool starts beeping (5 seconds) and release the fingers from the trigger and L/R switch during this beeping.

De-locking the shut-off setting: same procedure.

Locking the left rotation:

Remove the battery.

Push the L/R switch and place the battery, hold the L/R switch until the tool starts beeping (+/- 10 seconds) and release the L/R switch during this beeping.

De-locking the left rotation: same procedure.

LED indicator and beeper on the tool shows the following status:

Status of the LED indicator and beeper	Status of the tool	Action to be taken
Light up in red, yellow and green together for one second. A long beep for one second.	The tool is OK to use	-
Light up in red for one second. A long beep for one second.	The preset torque is not reached, operator released the trigger before shut-off.	The screwing fastener must be performed again. Operator to hold the trigger until the tool shuts-off
Light up in green.	The preset torque is reached and the tightening is OK.	-
Blinks in yellow for five times. Five short beeps	The battery power becomes low	Replace the battery with a fully charged one
Light up in yellow for five seconds. A long beep for five seconds	The battery power is used up, the tools stops immediatly.	Replace the battery with a fully charged one
Yellow light & green light are blinking at the same time	The tool is in reverse operation	-

Maintenance:

Check the tool regularly for loose bolts/screws or parts.

In case of power loss: Have the tool repaired.

Only trained and qualified engineers are allowed to adjust or repair the tool.

In case of disposal of the tool, follow local regulations, so as much as possible can be recycled. Do not throw it in the normal waste bin.

The tool should be maintained regularly to minimize the noise emission and occurring vibration.

ERROR Mode: Display by LED

Error Mode	Error Cause	Solutions
E2	Motor overheated	Remove battery pack and put aside for cooling
E3	Motor damaged	Send back to repair center for checking
E4	Trigger damaged	Send back to repair center for checking
E8	Pulse unit damaged or overheated	Damaged: Replace pulse unit Overheated: Put aside and reattach the battery pack after the puls unit has cooled down.

Intended use:

The user or the user's employer shall assess the specific use that can be present as a result of each use.

Never use the tool otherwise than the tool is designed for and as explained in this manual.

Damages as a consequence of not following this manual, or caused by incorrect use or incorrect repairs, will never be covered by our warranty and we will have no responsibility for it. We reserve the right for technical improvements, without prior notification.

This tool is designed for tightening processes on threaded fasteners, if used otherwise a risk assessment has to be made by the employer/user.

Warranty

The warranty period from the date of purchase is as follows:

- 12 months on Yokota , Toku and Red Rooster tools;
- 3 months on spare parts of tools, which are repaired by us.

Warranty covers material or construction mistakes of the manufacturer, which are clearly definable. Replacement of parts or repair by an official Yokota/Red Rooster service workshop is free of charge, when the tool is covered by warranty. Freight or postage is for the account of the buyer. Damage attributable to a normal wear, overloading or incorrect use is excluded from warranty. Always consult this manual! Replacement of tools as a consequence of warranty claims is no part of the warranty arrangements.

Also claims for loss of production and/or other damages are excluded from this warranty.

Repairs under warranty can only be considered, when the tool is in its original state and it is accompanied by a copy of the purchase invoice. Warranty claims have to be made through the dealer, who has supplied the tool concerned.

Declaration of Conformity

CE Declaration of Conformity

Brand: RedRoosterIndustrial

Product: Impulse Wrenches

Type: RRI-BIM25T

Capacity: 15 - 25

2015.03011D

WE, RAMI YOKOTA B.V., hereby declare that this product is conform the European Directive 2006/42/EG and, the standard EN ISO 11148-6

Technical file available from Rami Yokota BV:

RAMI YOKOTA BV

De Ruyterkade 120

1011 AB Amsterdam

THE NETHERLANDS

UK Declaration of Conformity

Brand: RedRoosterIndustrial

Product: Impulse Wrenches

Type: RRI-BIM25T

Capacity: 15 - 25

2015.03011D

WE, RAMI YOKOTA B.V. , hereby declare that this product is conform the Supply of Machinery (Safety) Regulations 2008 No. 1597, amendment 2001 No. 2157 and the standard EN ISO 11148-6

Technical file available from Rami Yokota BV:

RAMI YOKOTA BV

De Ruyterkade 120

1011 AB Amsterdam

THE NETHERLANDS

Date: 09-05-2022

Place: Amsterdam

Signature:



N. Nauta

Managing Director RAMI YOKOTA BV

www.rami-yokota.com

RAMI YOKOTA BV | DE RUYTERKADE 120 | 1011 AB AMSTERDAM | THE NETHERLANDS
Tel. +31-(0)20-5318800 E-mail info@rami-yokota.com www.rami-yokota.com

