

**NovaTork®**

# **CALIBRATION ADAPTER - 3/8", 17+18 MM HEX ZJ2-18**

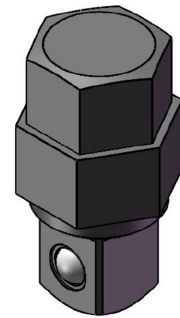

## **Specifications**

<b>Brand</b>	<b>NovaTork</b>
<b>Square Drive</b>	<b>3/8"</b>
<b>Hexagon</b>	<b>17+18</b>
<b>EAN</b>	<b>8717981440146</b>