

CALIBRATION ADAPTER - 1/2", 22+23 MM HEX ZJ3-23

Related products



TES3150
Line Checker TES 15 ~ 150 Nm



TES3250
Line Checker TES 25 ~ 250 Nm

TES3400
Line Checker TES 40 ~ 400 Nm

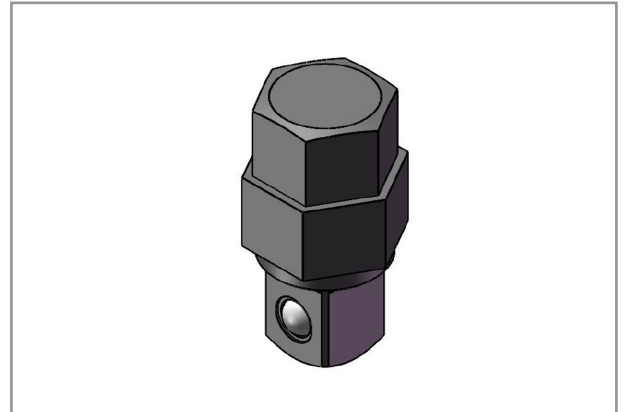

Specifications

Brand	NovaTork
Square Drive	1/2"
Hexagon	22+23
EAN	8717981440184